

Data Sheet



Article number: 203280M16200A1U

Description: E+G levelling foot
GN 32-80-M16-200-A1-U

Note: U Without nut, Hexagon socket at the top, Wrench flat at the bottom

Measures

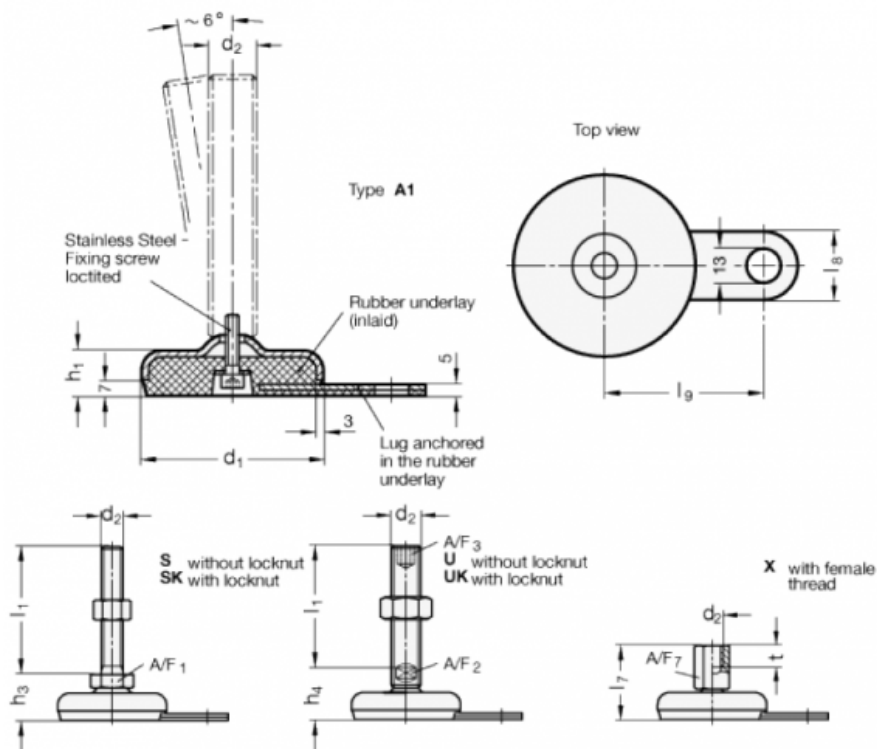

A/F2 = 12

I9 = 70

A/F3 = 8

d1 = 80

d2 = M16

h1 = 20

h4 = 34

l1 = 200

l8 = 30